

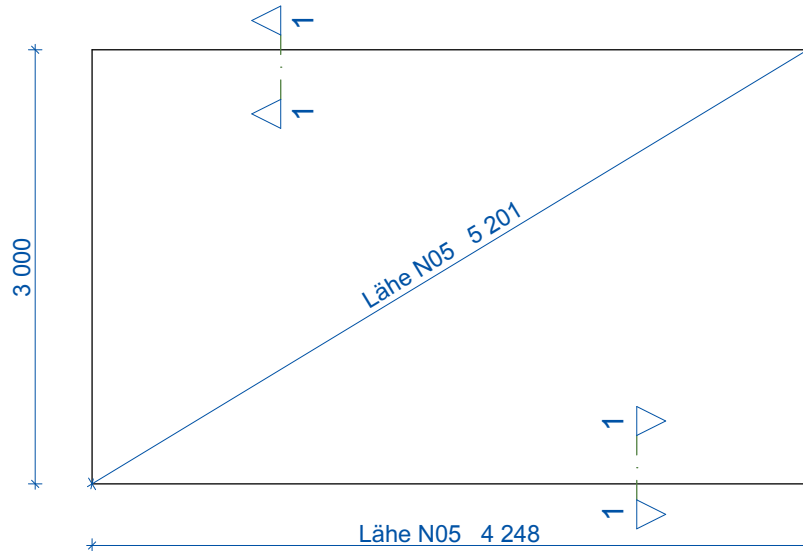

OPTION 1 - PLATE BASE

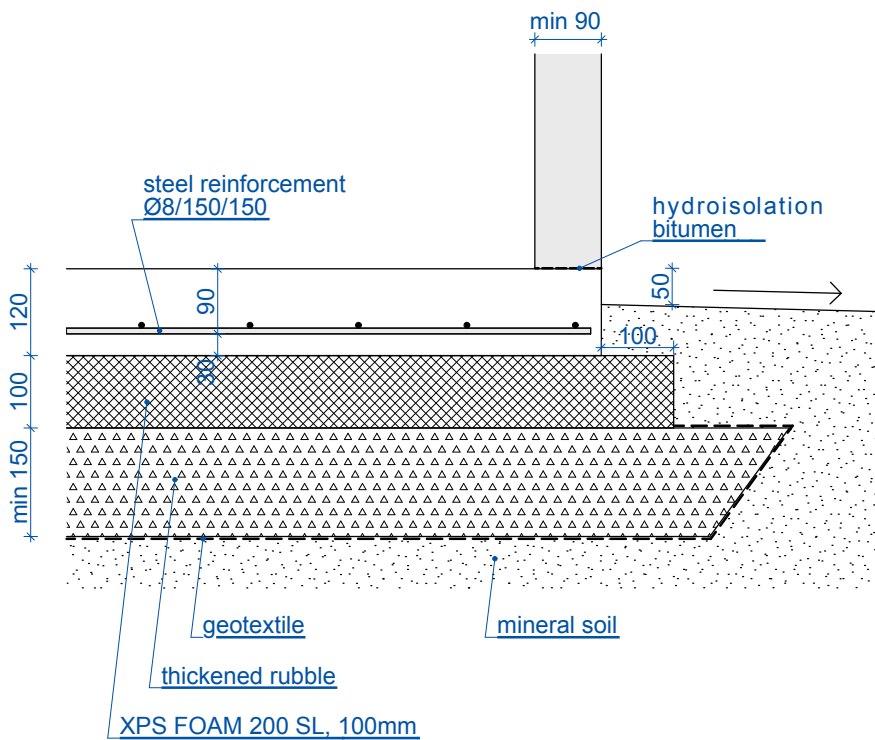

Foundation plan M 1:50



Foundation section M 1:10

Notes:

1. Foundation concrete plate type C25/30, environmental class XC2.
2. Reinforcing bars are weldable rib bars, yield strength $f_{yk}=400\text{...}600$ MPa.
3. Thickened rubble thickness factor 0,95.



OPTION 2 – RIBBON BASE

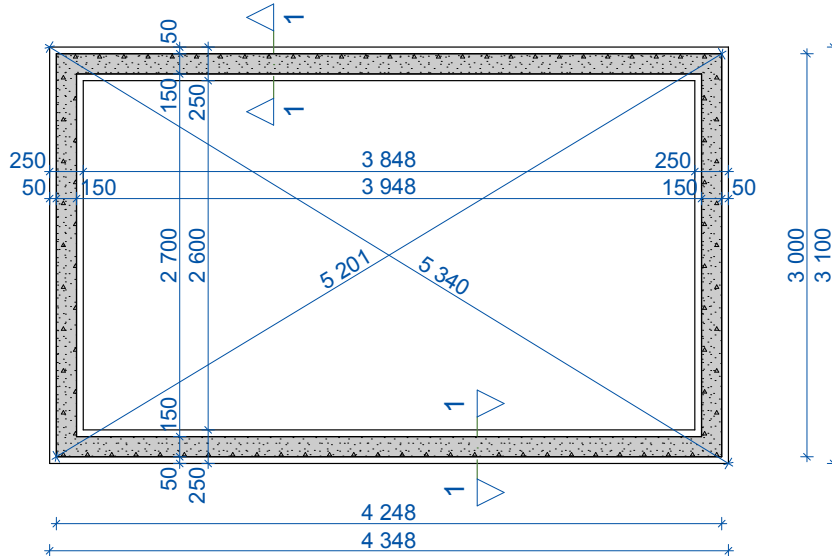

Foundation plan M 1:50

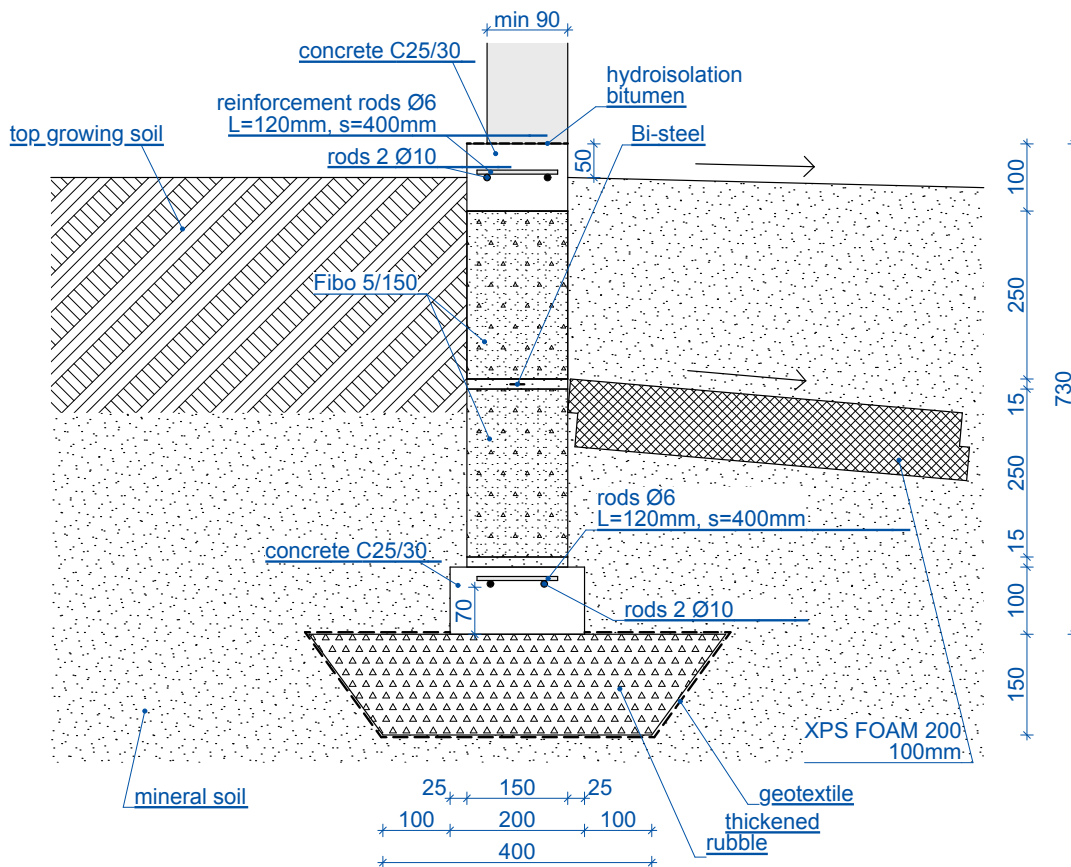

Foundation section M 1:10

Notes:

1. Foundation concrete plate type C25/30, environmental class XC2.
2. Reinforcing rods are weldable rib rods, yield strength $f_{yk}=400\text{--}600$ MPa.
3. Thickened rubble thickness factor 0,95.
4. Lay bricks with full horizontal and vertical joints, mortar paste compression strength min 20 MPa.
5. Bi-steel fully inside brick mortar
6. When laying blocks, use a wall mixture with normal compressive strength 8MPa.
7. In case of high groundwater, solve the foundation with the drainage system.



No 5 WALL

